

Dear Customer,

Thank you for purchasing the “**COSMO QUANTUM 2.0**” series water purifier. Rest assured that all our products are designed and manufactured to the highest standards.

We would like you to utilize all the features of our device, including our internal smart filtration system.

Now you can enjoy an unlimited supply of high-quality, healthy, clean water, just the way water is meant to be consumed - at cold, hot or ambient temperatures.

We care about the same things you care about: you and your family’s health. We are here to make every day healthier and easier for you.

Please read this manual carefully before operating.

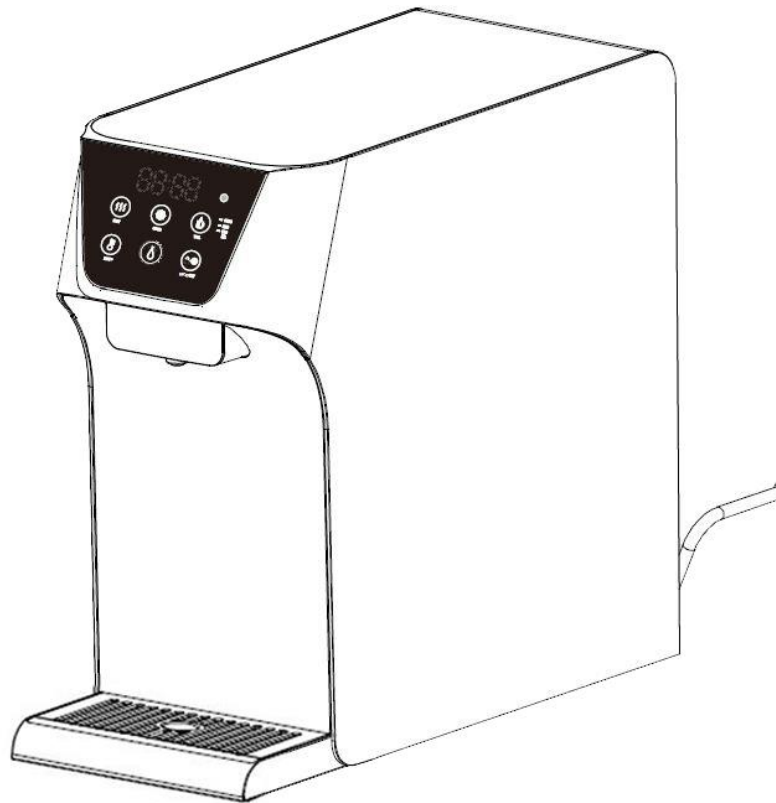

## **COSMO QUANTUM 2.0**

## SAFETY PRECAUTIONS

1. Keep water dispenser out of reach from children. Do not let them operate the appliances without supervision.
2. To avoid risk of electrical shock, do not immerse product, cord, or plug into water or any other liquids.
3. This product is not intended for use by person (including children) with reduced physical, sensory or mental capabilities unless they have been given supervision or instruction concerning use of the appliance by a person responsible for their safety.
4. If the power cord or plug is damaged, seek help immediately for it to be replaced by the service centre or a qualified service technician to avoid hazard.

## WARNING |

To reduce the risk of fire, electrical shock or injury to persons or property, please read and follow instructions below carefully.

1. Always operate the product from a power source of the same voltage, frequency and rating as indicated on the product identification marking.
2. Do not operate this product if it has a damaged cord or plug, or if it has malfunctioned and appears damaged in any way. Return the complete product to the place of purchase for inspection, reparation or replacement.
3. This product should not be used in the immediate vicinity of a large body of water such as a bathtub, washbowls, swimming pool, etc. where the likelihood of immersion or splashing could occur.
4. Always switch off and unplug the power plug from the outlet before assembling or disassembling parts, when not in use, and before cleaning. Fully assemble the set before operating.
5. Avoid contacting with moving parts. Do not insert any object through the guard when the set is operating.
6. Always disconnect the appliance when moving it from one location to another.

# PRODUCT DESCRIPTION

## 1. GENERAL OVERVIEW

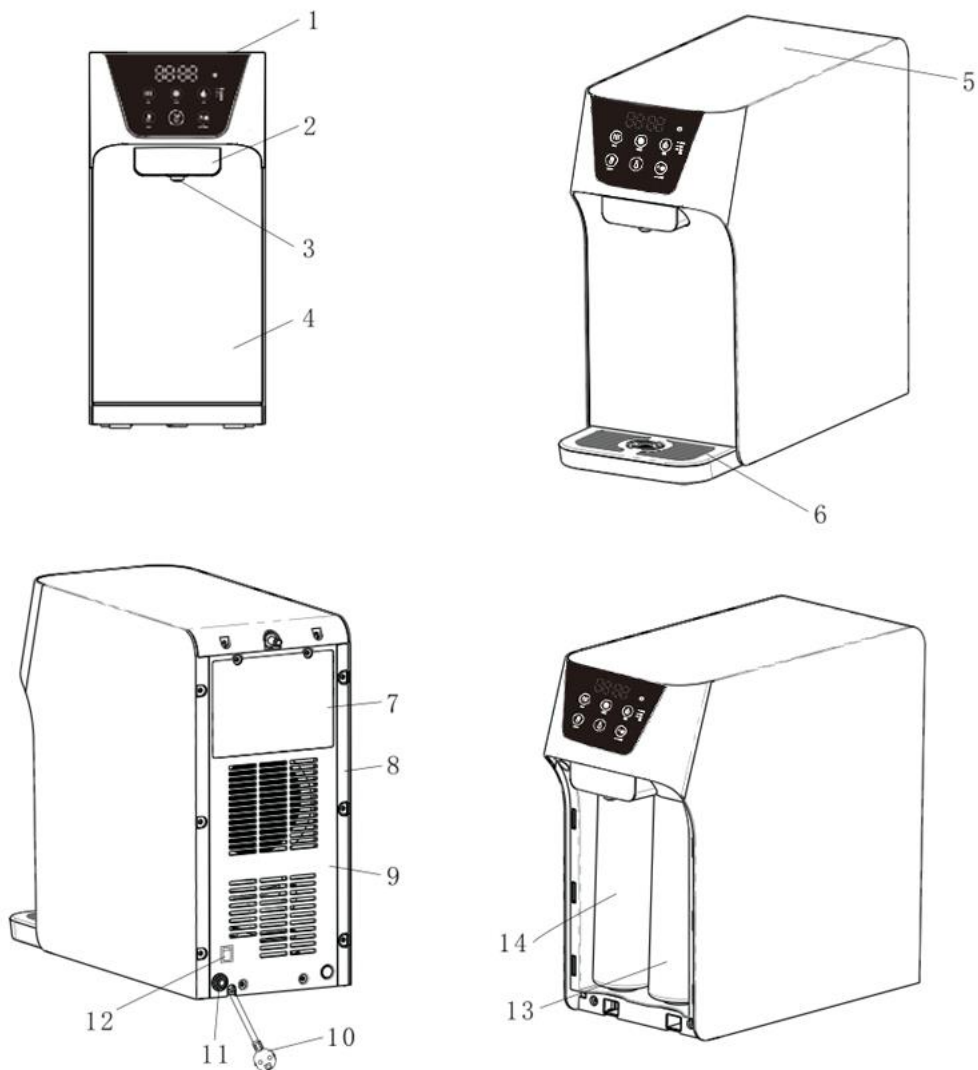

- 1. User Interface/ UI
- 2. Decorative Plate
- 3. Water Spout
- 4. Front Panel

- 5. Top Cover
- 6. # Drip Collector
- 7. Control Panel
- 8. Side Panel
- 9. Back Panel
- 10. Power Cord
- 11. Water Inlet
- 12. Heating System Switch ON(1)/ OFF (0)
- 13. Stage 1<sup>st</sup> Filter (Sediment & Carbon Composite)
- 14. Stage 2<sup>nd</sup> Filter (UF & ACF Composite)

## 2. OPERATION USER INTERFACE (UI)

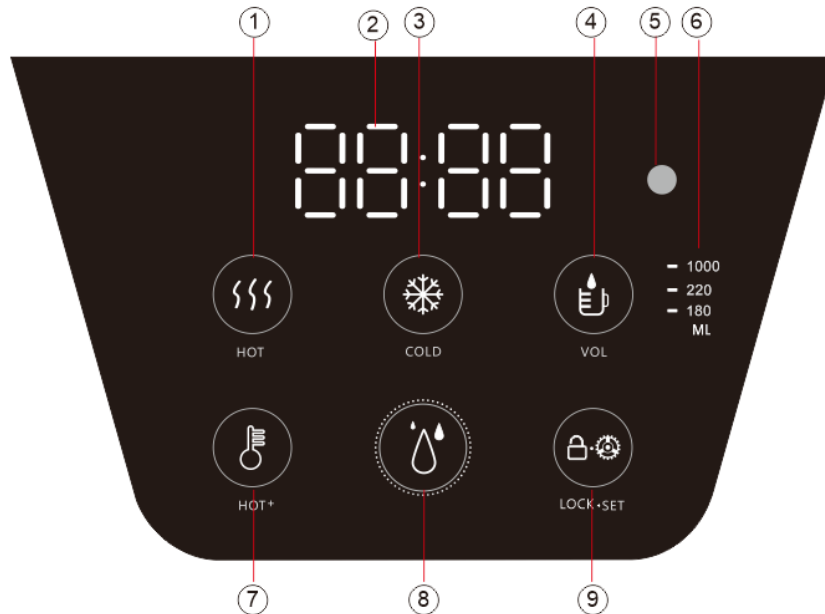

- |                           |                                   |
|---------------------------|-----------------------------------|
| ① Hot Water Button        | ⑥ Volume Option (180/220/1000 ml) |
| ② Clock/ Timer            | ⑦ Extra Hot+ /Reboiling Button    |
| ③ Cold Water Button       | ⑧ Water Dispensing/ Mixed Water/  |
| ④ Volume Selection Button | Setting Confirm Button            |
| ⑤ Energy Saving Sensor    | ⑨ Child Lock/Setting Button       |



## 3. DESCRIPTION OF BUTTON FUNCTIONS:



1. - Hot water dispensing button: Red and White light; used to start the hot water dispensing and setting mode plus “+” button.



\*When the machine starts heating the light shows red. When heating is finished, light will turn back to white.



\*When you start dispensing the hot water the light will be blinking red light. When dispensing is over light turns back to white. Press any button to stop in advance.











Note: When the machine is in heating status, light will always show red until heating ends. Then light will turn back to white.

2.  - Clock/ Timer: White light is used to display timer and setting programming data.
3.  - Cold water dispensing button: Blue and White light is used to start the cold water dispensing and setting mode reduce “-”
 

\*When the machine starts the cooling, the  light shows blue. When cooling is finished, the  light will turn back to white.





\*When the machine starts dispensing the cold water, the  light will be blinking blue light. When the cold water dispensing is over, the  light will turn back to white. Press any button to stop.



Note: When the machine is in cooling status, the  light will always be blue until the cooling is finished. The  light will then turn back to white again.
4.  - Volume selection button: White light, used to select the fixed volume of water. The Volume selection button light is always on and stays at one of the volume levels according to the last dispensing volume. There are 3 volume options, 180/220/1000 ml.
 



Caution: To avoid the emergency flow meter or programming malfunction, the machine will automatically stop when it continuously dispenses water for 2 minutes or 1.5 litres.
5.  - Volume option button: White light, showing the selected flow value.
6.  - Photo-resistance sensor: Used to start and end energy saving mode
7.  Extra Hot/ Reboiling Button: Red and White light, used to start and end the reboiling function. When the reboiling function is activated, the  light will be red until the hot water reaches the setting temperature, then the  light will turn back to white. The default light is white and you can stop it at any time by pressing it.
8.  - Water Dispensing/ Mixed Water/ Setting Confirm Button: Red and White light; Operate together with cold or hot water button to dispense cold or hot water. Operate alone for dispensing mixed water or end setting confirmation. The default light shows white, when used with cold water and hot water button to dispense cold water and hot water and when used alone for dispensing the mixed water. When the life of the filter element is about to expire, the  light will become red, reminding the customer to replace the filters.
9.  - Child Lock/ Setting Button: Blue and White light; used to set timer, temperature, filter lifespan, flow volume, and energy saving. The default light shows White. Keep pressing for 5 seconds to enter into the settings mode,  light will then be blue. When Child lock is unlocked and,  light will be blue.

## DESCRIPTION OF BUTTON OPERATION



### A. HOT WATER DISPENSING



Press the  button first then  button (indicated by a buzzer sound and red light). Then press the  button within 5 seconds to dispense a predetermined quantity of hot water. When done, the  light will turn white and you can press any button to stop the dispensing.



Note: 1. Before or after pressing the  button, you can press the  button to select the preferred volume to dispense.

2. When the machine is heating, the  button will be red, after touching the button you will hear the buzzer sounds, the  light will show blinking red light.



### B. COLD WATER DISPENSING



Press the  button first (indicated by a buzzer sound and blue light). Then press the  button within 5 seconds to dispense a predetermined quantity of cold water. When done, the  light will turn white and you can press any button to stop the dispensing.

Note: 1. Before or after pressing the  button, you can press the  button to select the preferred volume to dispense.

2. When the machine is cooling, the  button will be blue, after touching the button you will hear the buzzer sounds,  light will show blinking blue light.

### C. MIXED WATER DISPENSING (Default temp: 30-45 °C)

Press the  button then  button to get mixed water (indicated by a buzzer sound and white light). You can press any button to stop the dispensing in advance.

Note: Before or after pressing the  button, you can press the  button to select the preferred volume to dispense.

Mixed water: Cold and Hot water Distribution Table

Needed Capacity	Cold Capacity	Hot Capacity
1000ml	420ml	580ml
220ml	90ml	130ml
180ml	80ml	100ml



Note: This data is based on hot water at 90 °C and cold water at 20 °C. The temperature of the mixed water will change due to the temperature difference between cold and hot water.

## D. REBOILING/ EXTRA HOT WATER

1. To heat the hot water to the reboiling temperature, press  button and the light will turn red until the water reaches the setting value.

2. During reboiling status, the  button will have a stable red light.

If there is no operation, only when the hot water temperature drops below the starting temperature (5 °C below setting temperature), the  button will turn back to white.

If there is operation to start the hot water dispensing,  light will turn back to white. To stop the reboiling function, just press  button again and the light will turn back to white.

## E. VOLUME SELECTION

1. The volume value is 180ml by default, and the flow rate is based on the flow meter calculation.







2. Press the  button (indicated by a buzzer sound and white light) and select preferred volume among the different volume options.

Note: When the dispensing of hot, cold, or mixed water is completed, the volume will stay at the previously selected volume rate and the light will remain white.

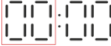

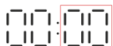

## F. SETTING (DEFAULT IS WHITE LIGHT)

Attention: Anytime during setting status, you can press the  button to end setting in advance or do not have any operation for 10 seconds automatically exit.



## 1. TIME SETTING

- 1.1 Press  button and hold for 5 seconds (indicated by a buzzer sound and all icon  light on) to set the time hour. The figure in the red frame on the left starts flashing. Press the  button to increase the number of hours, and the  button to decrease the number of hours.
- 1.2 When the clock hour setting is completed, press the  button again where the red frame number on the right starts flashing.  Press the  button to increase the number of minutes, and the  button to decrease the number of minutes.

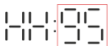

## 2. HOT WATER TEMPERATURE SETTING (DEFAULT TEMP IS 92°C)

- 2.1 When the minute setting is completed, press the  button again and the right side number in red frame will start flashing.  System enter to hot water temperature setting status (hot water button light will show red). Press the  button to increase the temperature, and the  button to reduce the temperature. (Hot water maximum temperature setting range is 40°C -94°C)

## 3. EXTRA HOT WATER TEMPERATURE SETTING (DEFAULT TEMP 95°C)

- 3.1 When the hot water temperature setting is completed, press the  button again and the right side number in red frame will start flashing . The system will then enter to the extra hot water temperature setting status. (Extra hot button light will be red). Press the  button to increase the temperature, and the  button to reduce the temperature. (Extra hot water maximum temp setting range is 85°C -96°C)

## 4. COLD WATER TEMPERATURE SETTING (DEFAULT TEMP IS 5°C)

- 4.1 When the extra hot water temperature setting is completed, press the  button again. The right side number in the red frame starts flashing and the system enter to set the cold water temperature setting status (Cold water button light show blue). Press the  button to increase temperature; press the  button to decrease temperature (minimum setting range 3°C -10°C)  
Notes: The above setting is cooling stop temperature, and the difference between the cooling starting and stop is 5°C. For example: Setting the temp is 5°C, and cooling starting temp is 10°C.





## 5. FILTER LIFESPAN SETTING

5.1 When the setting is completed, press the  button again, the right side number in red frame starts flashing and system enter to the filter lifespan reset setting status:

reset setting status: FL:01

5.2 The initial data show the real status of filter been used FL:00

5.3 To reset filter life, press the  or  button. The data on the right changes from “01/02/03” to “00”

5.4 Filter life pattern comparison data sheet

Used flow	≥ 5000L	≥ 1400L	≥ 700L	≥ 200L
Used Time	≥ 270 Days	≥ 120 Days	≥ 60 Days	≥ 10 Days
Pattern Number	00	01	02	03

Calculation method: Calculation with flow-meter and time simultaneously, which one reached first as consumer standard. When the lifespan of filter is less than 200L or the time is less than 10 days, the dispensing button  light will show red. When the filter element life is due, the buzzer will sounds 3 times every 6 hours until it is reset.

## 5.5 Filter Replacement Instruction

Step 1 : Take out water tray

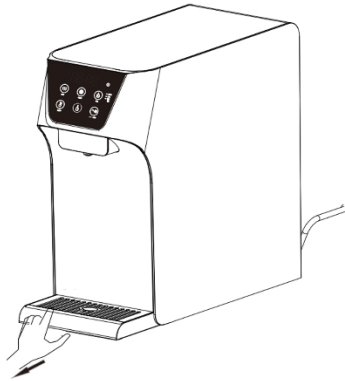

Step 2 : Take out front panel

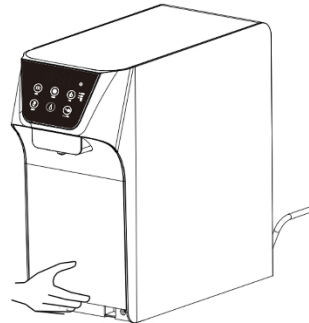

Step 3 : Unscrew the old filter and replace with new

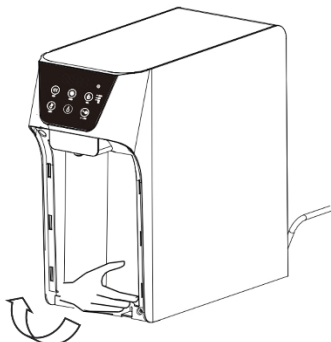

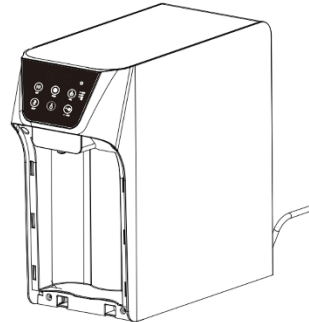

Step 4 : Install back the front panel and tray





## 6. ENERGY-SAVING MODE SETTING (DEFAULT STATUS IS “OFF”)

7.1 After the filter life setting is completed, press the  button again. The red frame number on the right starting flashing. Enter to energy saving mode.

Press the  or  button, the figure on the right changes “ON” to open.



Press the  or  button, the figure on the right changes “OFF” to close.



## 7. END SETTING

7.1 When the energy saving mode setting is completed, press the  button again to exit the setting mode, the display window will go back to showing the time.

# DESCRIPTION OF STANDBY STATUS

1. When the machine is not operated for 10 minutes, the system automatically enters to standby status, the operation panel displays as the right picture: and the water dispensing and timer button is on, all the other lights will be off.
2. In standby mode, the heating and cooling function works normally.
3. In standby mode, press any button to exit, meanwhile all the buttons light on immediately.

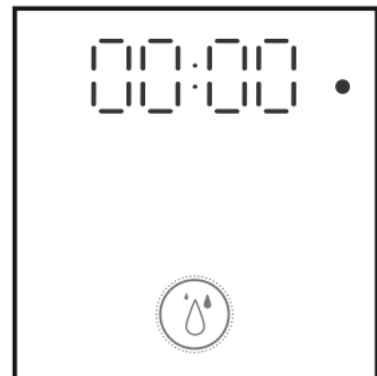

# DESCRIPTION OF ENERGY SAVING FUNCTION

When the energy-saving function is on, if the light-sensitive signal is detected to be continuously disconnected for 30 mins (less than 0.5 Lux in a dark environment), the system will enter the energy-saving status:

1. Under the energy-saving mode, the operation panel displays as the right picture: except the timer (clock) button is on, all others light off.
2. Under energy saving status, both heating and cooling stop working. If there is any button operation, exit the energy-saving mode immediately, heating and cooling re-starting, all the button lights on normally. If it is detected again that the light-sensitive signal is continuously connected for 3 Mins (more than 0.5 Lux in day environment), the system automatic exits the energy-saving mode, starts the normal heating and cooling function, and all the button lights up.

## DESCRIPTION OF NIGHT LIGHT & PROGRAMME MEMORY

- The night light is always on show blue light as default.
- When dispensing hot water, the night light will turn red in colour.
- When dispensing cold water, the night light will turn blue in colour.
- When dispensing mixed-water, the night light will turn red and blue both.
- When the machine is powered off, all settings data could be saved for one week long, otherwise you need re-setting.
- Any buttons are touched, the buzzer will be activated, and the sound with a chord voice.

## MACHINE FIRST TIME USE ATTENTIONS



Power on for the first time:

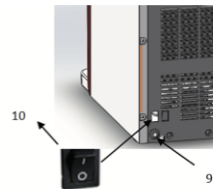

1. Before power on, please check whether the raw water pipeline is well connected. Make sure the heating switch on the back of the machine is on OFF (0) Status.

**[ Note ON--(1) side , OFF -(0) side ]**





2. Connect the power plug to the power supply, the operation panel is as shown on the top right: the hot water button lights up with red light flashing.

First of all, you must press the  and  button to dispense hot water for 10 seconds to let water flow into the system.

**(Notes: All button is malfunction except the  and , all other button can be active only after you execute hot water dispensing 10S).**

3. Hot and Cold water inlet

After the first water filling operation, place the cups under the spout; press the  button again, press the  button again. Start the hot water dispensing until there is water come out from nozzle.

Press  and then press the  button to start the cold water dispensing.

4. Turn on the heating switch at the rear of the machine to start the heating function.

## PRODUCT SPECIFICATION & PARAMETER

Item	Power Supply	110-120 Volts	220-230 Volts
1	Voltage Frequency Cooling Power Heating Power Lock Set Power Total Power Current Refrigerant Gas Climate Class	115V, 1 Phase 60Hz 80W 500W 0.4W 580.4W 5A R134a/1.34OZ ST/T	230V, 1 Phase 50Hz/ 60Hz 80W 500W 0.4W 580.4W 3A R134a/38G ST/T
2	Cold water output Cold water Temp	0.40GAL/Min 37.4°F-50°F	1.5L/Min 3°C-10°C
3	Hot water output Hot water Temp range Extra Heating Temp Range	0.40GAL/Min 192°F - 201°F 201°F - 206°F	1.5L/Min 89°C - 94°C 94°C - 97°C
4	Filter Set	Lifespan: 5000L (1320GAL)/ 9-12 Months	

5	Applicable water pressure	0.4Mpa
6	Rate Pure Water Flow (Water pressure 0.1-0.4Mpa)	1.0-1.2L/M 0.26 – 0.31 GAL/M
7	Applicable Water	Tap/ City Water
8	Product Size Package Size	418(L)*185(W)*394(H) MM 465(L)*245(W)*435(H) MM
9	Net. Weight Gross Weight	11.5kgs/25.5lbc 12.5kg/27.5lbs

## INSTALLATION & UNPACKING

Please cut off water source before replacing filters. Never remove or replace filters in water running state.

1. Open the top of the packing case, take out the top foam and its accessories... Put the accessories aside.
2. Unpack the product, install the water collector.
3. Take out the quick joint, and install it on the water pipe.

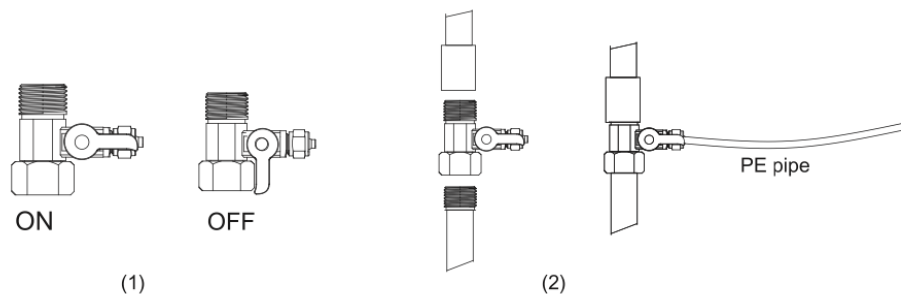

4. Filter should be cleaned for first time usage. Turn on the faucet to flush the filter for 10 minutes. When installing the machine, please ensure that there is a 10 cm gap between the rear of the water dispenser and the wall so that

there is proper airflow for the air inlet and outlet.

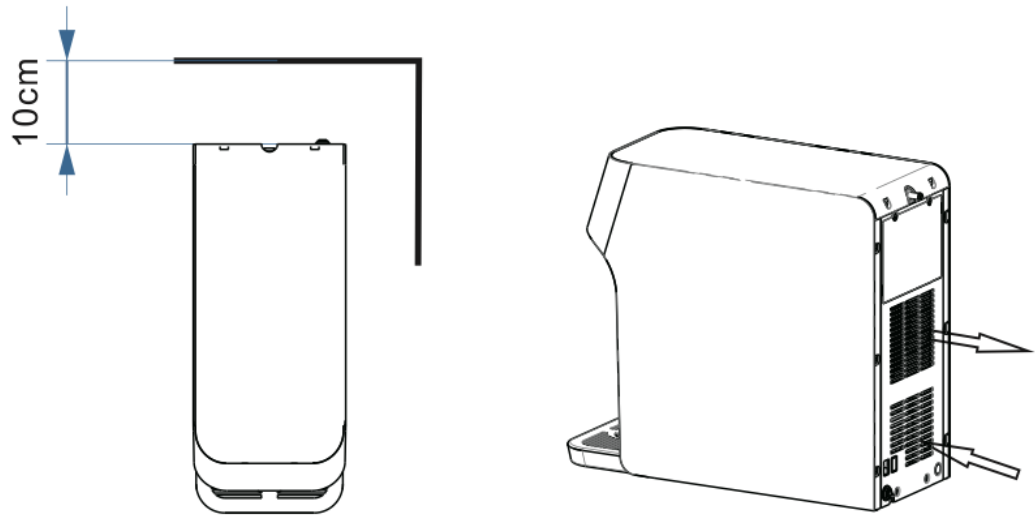

5. Drip tray cover must be properly placed inside the machine. No suspending in mid-air to prevent it from falling off.

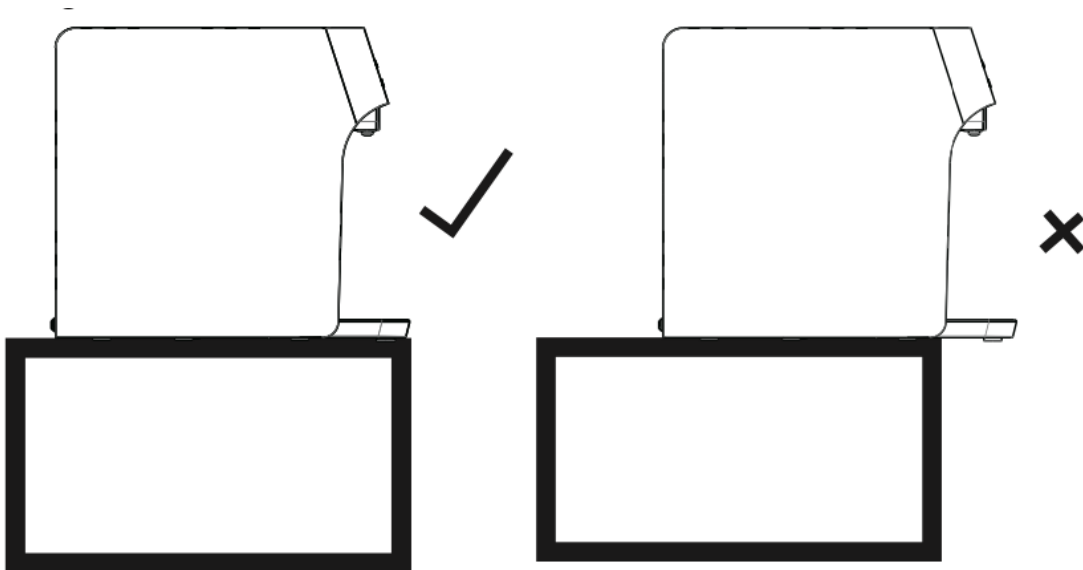

6. Take out the pin of the quick joint at the rear of the product's base plate, and then take out the blue plug. Insert the water inlet PE pipe in the quick joint, and tighten the pin.

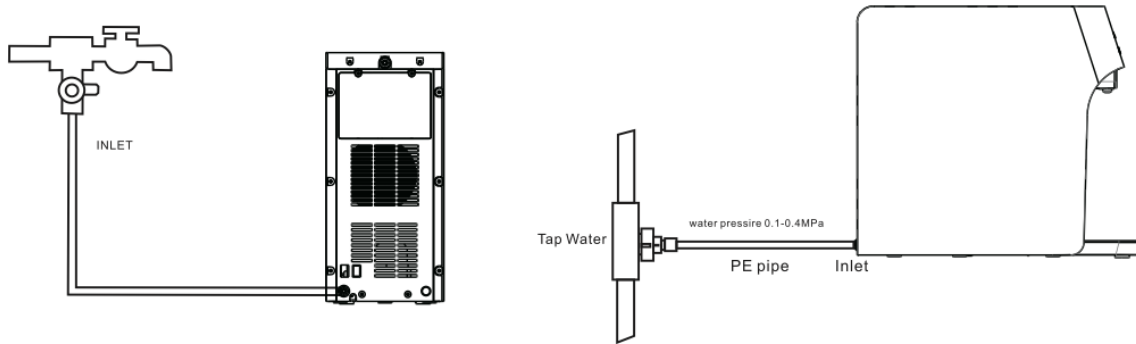

7. The water cooler plug cord into a ground fault interrupter receptacle... After installing, supply power, and begin to use the water purifier.
8. When installing filter and replace filter please turn off the water and power supply before installation and replacement.

**ATTENTIONS:**

It is a normal state that the following circumstances occur when the water purifier is used.

1. During the heating, the heating tube may generate slight noises. This is a normal state.
2. When the dispenser is being heated without water, the anti dry-burning device will disconnect automatically and can not reset by its own. The reset must be completed by a professional technician. The design is in accordance with the national safety requirements

## TROUBLESHOOTING GUIDE

In case of failure, please carry out inspection according to the requirements below. If unresolved, please contact the local service agency.

Failure & Error Code	Cause	Solution
Small Water Flow	Low water pressure	Check and adjust the water supply
	Filters not replaced in time, beyond the use time	Replace filters
Water Leakage	Pipe not connected properly	Inspect the connector to connect the pipe properly
	Water pipe and PE pipe burst	Replace the water pipe and PE pipe

Electric Leakage	Machine in poor contact with the ground	Use a three-pin socket with earth wire making the machine grounded properly
Noisy Operation	Not installed Steadily	Place the machine on a steady & Solid surface
Machine Fails to Run	Power Supply not put through	Switch on Power Supply
E1:00	Cold Water NTC Error	Please contact us
	Machine does not start the heating and cooling function	
E2:00	Hot Water NTC Error	
	Machine does not start the heating and cooling function	
E3:00	Flow Meter Error	
	Machine does not start the heating and cooling function	
E4:00	Lock Set LED Error	
	The machine heating and cooling starts normally but the  button keeps flashing every second in blue	
E5:00	Water Shortage Error	Check the tap water supply

Contact information:

**Hotline:** +65 6977-9637

**WhatsApp /Text:** +65 8875-4074

**Email:** enquiry@waterdispenser.com.sg